

96452/96454

Infrared Motion Sensor Instruction Manual



Welcome to use 96452/96454 infrared motion sensor!

The product adopts good sensitivity detector and integrated circuit. It combines automation, convenience, safety, energy-efficiency and practical functions. It utilizes the infrared energy from humans as control-signal source and it can start the load at once when one enters the detection field. It can identify day and night automatically. It is easy to install and used widely.

SPECIFICATION:

Power Source: 220-240V/AC

Power Frequency: 50/60Hz

Ambient Light: <3-2000LUX (adjustable)

Time Delay: Min.10sec±3sec

Max.15min±2min

Rated Load: Max.1200W

300W

Detection Range: 180°

Detection Distance: 12m max(<24C°)

Working Temperature: -20~+40C°

Working Humidity: <93%RH

Power Consumption: approx 0.5W

Installation Height: 1.8-2.5m

Detection Moving Speed: 0.6-1.5m/s

FUNCTION:

- Can identify day and night: The consumer can adjust working state in different ambient light. It can work in the daytime and at night when it is adjusted on the "sun" position (max). It can work in the ambient light less than 3LUX when it is adjusted on the "3" position (min). As for the adjustment pattern, please refer to the testing pattern.
- Time-Delay is added continually: When it receives the second induction signals within the first induction, it will restart to time from that moment.

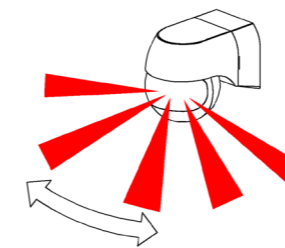

Good sensitivity

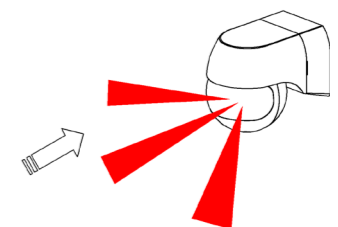
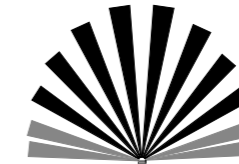

Poor sensitivity

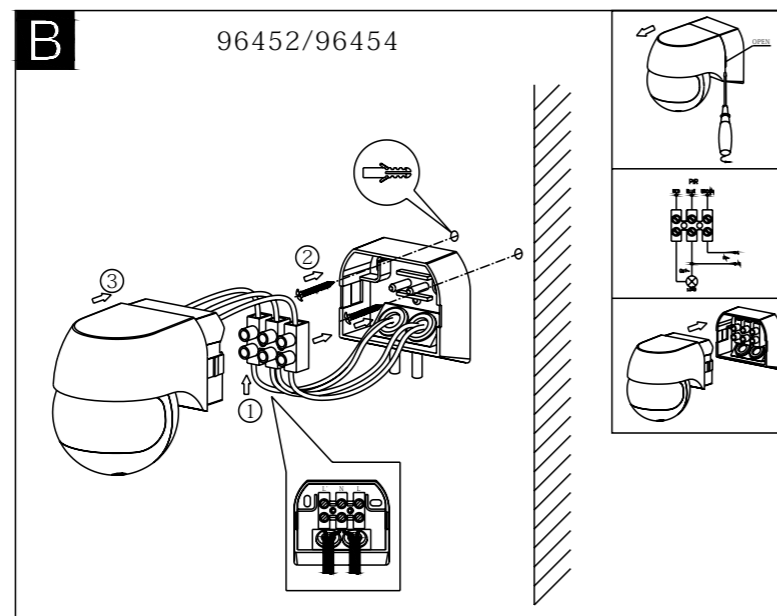
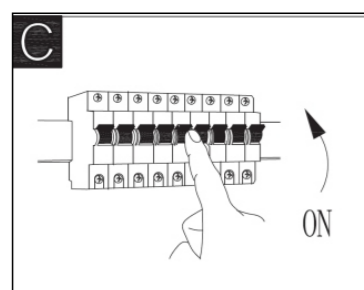
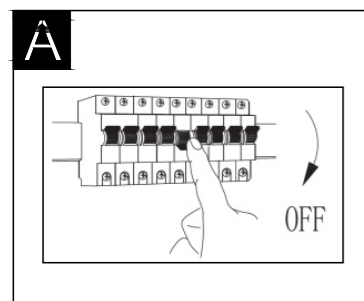

Tension	220-240V~ 50 Hz
Ampoule	Max. 800W Max. 400W
CE	Conforme aux normes européennes en vigueur.
	Classe II
	Non compatible avec l'utilisation d'un variateur d'intensité lumineuse.
	Les produits électriques usagés ne doivent pas être jetés avec les ordures ménagères. Veuillez utiliser les aménagements spécifiques prévus pour les traiter. Renseignez-vous auprès des autorités locales ou du revendeur pour obtenir le manchon à suivre ou matière de recyclage.
	Pour utilisation à l'intérieur. IP44

INSTALLATION ADVICE:

Since the detector responds to changes in temperature, avoid the following situations:

- Avoid pointing the detector towards objects with highly reflective surfaces, such as mirrors etc.
- Avoid mounting the detector near heat sources, such as heating vents, air conditioning units, light etc.
- Avoid pointing the detector towards objects that may move in the wind, such as curtains, tall plants etc.

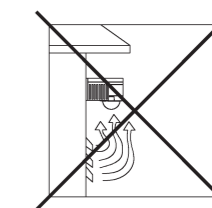
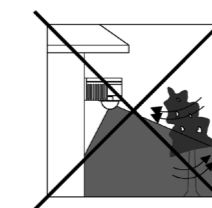
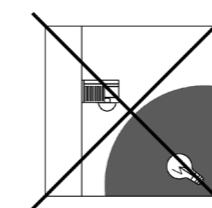
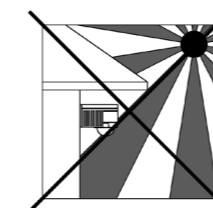

WARNING



Warning. Danger of death through electric shock!

- Must be installed by professional electrician
- Disconnect power source.
- Cover or shield any adjacent live components.
- Ensure device cannot be switched on.
- Check power supply is disconnected.

- Loosen the screw in the back and open the bottom (refer to figure 1).
- Find the wire hole with gasket on the downside of the sensor and guide the power wire through hole. Connect the power wire to connection-wire column according to the connection-wire diagram.
- Mount the bottom with included screw on the selected position. (refer to figure 2)
- Install the sensor on the bottom, tighten the screw and then test it.

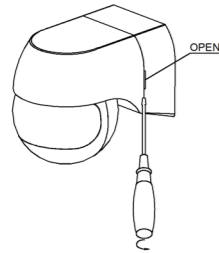

Figure 1

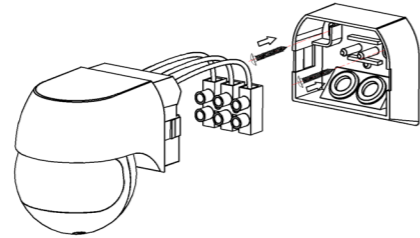
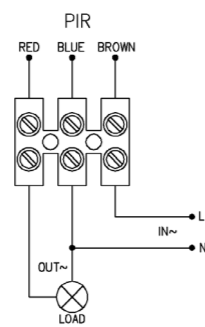

Figure 2

CONNECTION-WIRE DIAGRAM:

(See the right figure)



SENSOR INFORMATION:

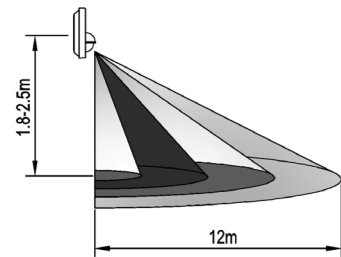

Height of installation: 1.8-2.5m

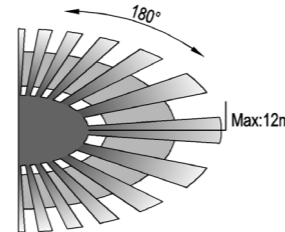

Detection Distance: Max.12m

TEST:

- Turn the TIME knob counter-clockwise on the minimum (10s). Turn the LUX knob clockwise on the maximum (sun).
- Switch on the power; the sensor and its connected lamp will have no signal at the beginning. After Warm-up 30sec, the sensor will start to work. If the sensor receives the induction signal, the lamp will turn on. When there is no another induction signal any more, the load will stop working within 10sec±3sec and the lamp will turn off.
- Turn LUX knob counter-clockwise to the minimum (3). If the ambient light is more than 3LUX, the sensor will not work and the lamp will stop working too. If the ambient light is less than 3LUX (darkness), the sensor will work. Under no induction signal condition, the sensor will stop working within 10sec±3sec.

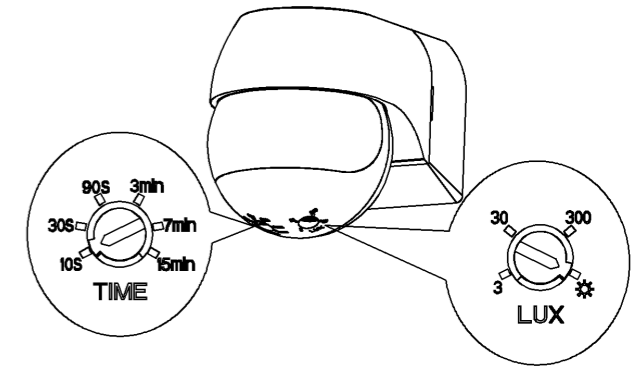

Note: when testing in daylight, please turn LUX knob to  (sun) position, otherwise the sensor will not work!

SOME PROBLEMS AND SOLUTIONS:

- The load does not work:
 - Please check if the connection of power source and load is correct.
 - Please check if the load is good.
 - Please check if the settings of working light correspond to ambient light.
- The sensitivity is poor:
 - Please check if there is any hindrance in front of the detector to affect it to receive the signals.
 - Please check if the ambient temperature is too high.
 - Please check if the induction signal source is in the detection field.
 - Please check if the installation height corresponds to the height required in the instruction.
 - Please check if the moving orientation is correct.
- The sensor can not shut off the load automatically:
 - Please check if there is continual signal in the detection field.
 - Please check if the time delay is set to the maximum position.
 - Please check if the power corresponds to the instructions.