

		R		L		C/L			
 100-240 V 50/60 Hz	 2 x 2.5 mm ²	 	 	(*) + 	(*) 	 + +	 	Dimmable 	Dimmable LED
240 V	Max.	400 W	400 W	400 VA	200 VA	400 VA	200 VA	75 W or 10 lamps max.	75 W or 10 lamps max.
	Min.	3 W	3 W	3 VA	3 VA	3 VA	3 VA	3 W	3 W
100 V	Max.	200 W	200 W	200 VA	100 VA	200 VA	100 VA	37 W or 10 lamps max.	37 W or 10 lamps max.
	Min.	3 W	3 W	3 VA	3 VA	3 VA	3 VA	3 W	3 W

- Ne pas mélanger différents modèles de charge sur le même produit
- Meng nooit verschillende modellen van ladingen op hetzelfde product
- Do not combine different types of load on a single product
- Unterschiedliche Arten von Leuchtstofflast sollten nicht am selben Gerät kombiniert werden
- Non mischiare diversi tipi di carica su un singolo prodotto
- No combine diferentes tipos de carga en un mismo producto
- Não misturar diferentes modelos de carga no mesmo produto

(*) • Utiliser uniquement des transformateurs prévus pour fonctionner avec des inters électroniques. (FR BE CA LU CH)

⚠ Tenir compte des pertes des transformateurs dans le calcul de la puissance. Les transformateurs doivent être chargés à plus de 60% de leur puissance.

(*) • Uitsluitend gebruikmaken van transformatoren die bestemd zijn om met elektronische schakelaars te functioneren. (NL BE)

⚠ Rekening houden met de verliezen van de transformatoren bij de berekening van het vermogen. De transformatoren moeten voor meer dan 60% van hun vermogen zijn geladen.

(*) • Use only with transformers designed to function with electronic switches. (GB CA IN IE US AU NZ)

⚠ Take account of transformer losses when calculating power. Transformers must be loaded at more than 60% of their power.

(*) • Nur Transformatoren benutzen, die dafür ausgelegt wurden, mit elektronischen Schaltern zu funktionieren. (DE AT LI LU CH)

⚠ Die Transformatorenverluste sind bei der Leistungsrechnung in Betracht zu ziehen. Die Transformatoren müssen auf mehr als 60% ihrer Leistung geladen werden.

(*) • Utilizzare esclusivamente trasformatori adatti per funzionare con interruttori elettronici. (IT CH)

⚠ Per calcolare la potenza, tener conto delle perdite dei trasformatori. I trasformatori devono essere caricati a più del 60% della loro potenza.

(*) • Utilizar únicamente los transformadores previstos para funcionar con interruptores electrónicos. (ES CL CO CR MX PE US VE)

⚠ Tener en cuenta las pérdidas de los transformadores en el cálculo de la potencia. Los transformadores deben estar cargados a más del 60% de su potencia.

(*) • Utilizar unicamente transformadores previstos para funcionar com inters electrónicos. (PT BR)

⚠ Ter em conta as perdas dos transformadores no cálculo da potência. Os transformadores devem ser carregados a mais de 60% da sua potência.

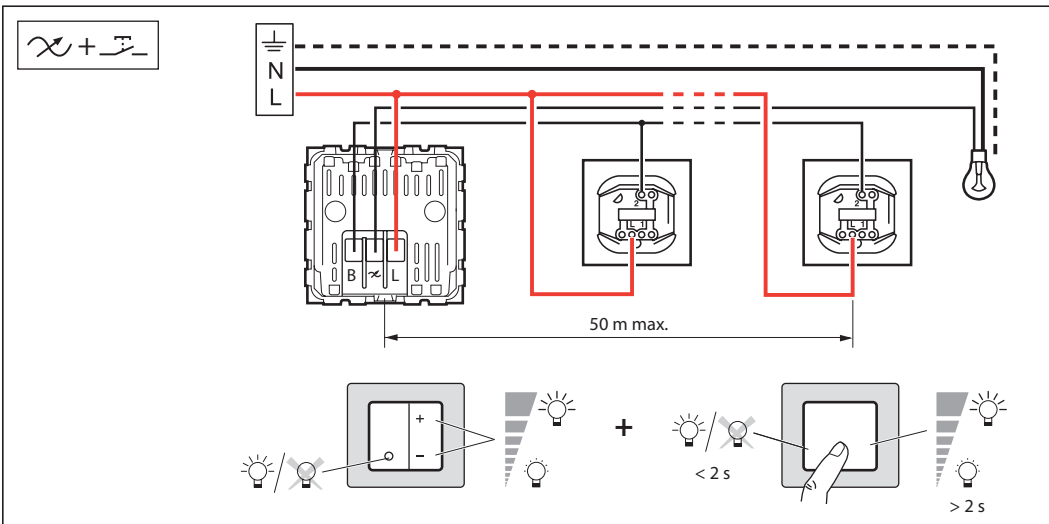
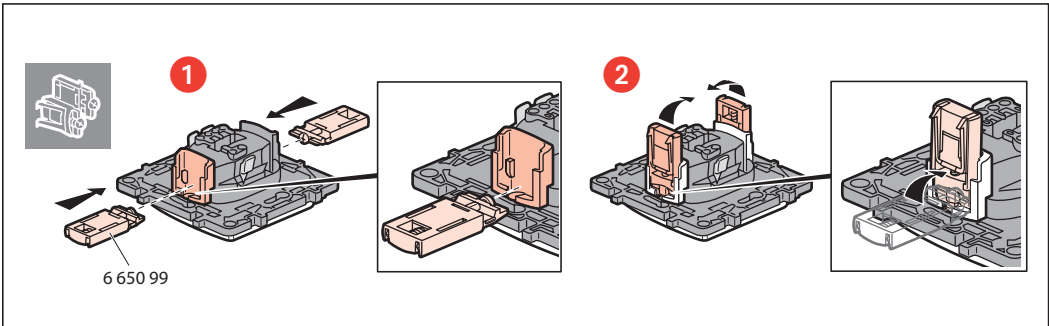
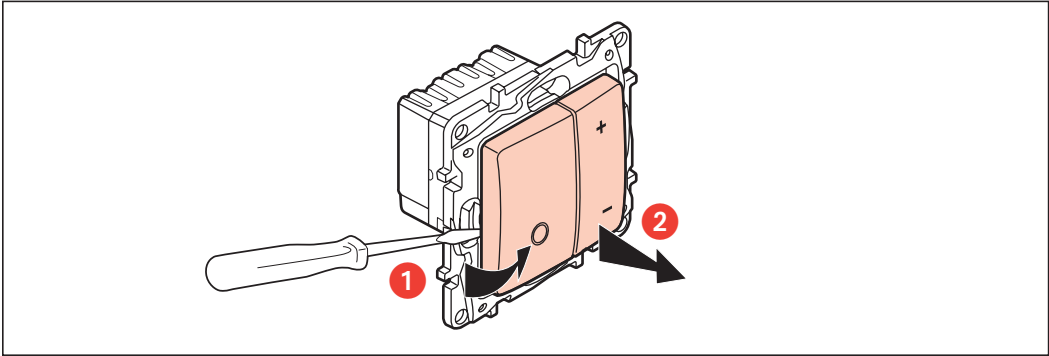
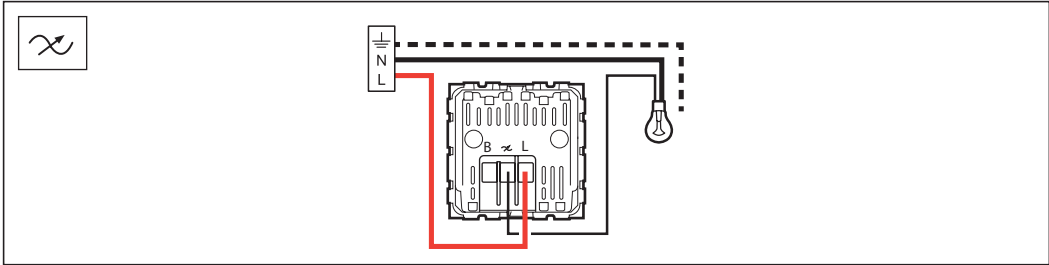



- Si la charge ne s'allume pas correctement, effectuer le réglage suivant :
- Gaat de lamp niet branden zoals het hoort, voer dan de volgende instelling uit:
- If the load does not switch on correctly, adjust as follows:
- Bei mangelhaftem Einschalten der Leuchte, folgenden Eingriff durchführen:
- Se il carico non si accende correttamente, procedere con la seguente regolazione :
- Si la carga no se activa correctamente, efectúe los ajustes siguientes :
- Se a carga não se acender correctamente, realizar o seguinte ajuste :

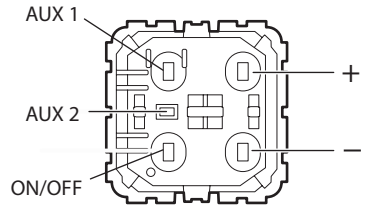

- Mode inductif forcé (plus de reconnaissance de charge automatique) : (clignotement vert)
- Geforceerde inductieve modus (geen ladingsherkenning) : (Knippert groen)
- Forced inductive mode (no load recognition) : (flashing green)
- Forcierter induktiver Modus (keine Lasterkennung) : (blinkt grün)
- Modalità induttiva forzata (nessun riconoscimento di carico) : (Lampeggia in verde)
- Modo inductivo forzado (no existe reconocimiento de carga) : (Parpadeo verde)
- Modo indutivo forçado (sem reconhecimento de carga) : (Intermitência verde)

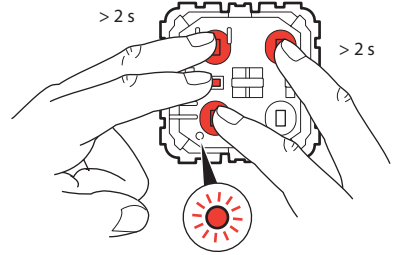

- Mode capacitif forcé (plus de reconnaissance de charge automatique) : (clignotement rouge)
- Geforceerde capacitive modus (geen ladingsherkenning) : (Knippert rood)
- Forced capacitive mode (no load recognition) : (flashing red)
- Forcierter kapazitiver Modus (keine Lasterkennung) : (blinkt rot)
- Modalità capacitiva forzata (nessun riconoscimento di carico) : (Lampeggia in rosso)
- Modo capacitivo forzado (no existe reconocimiento de carga) : (Parpadeo rojo)
- Modo capacitivo forçado (sem reconhecimento de carga) : (Intermitência vermelha)

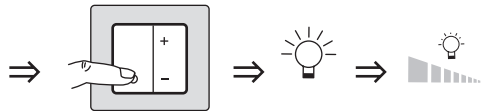
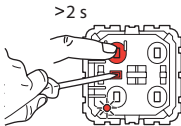
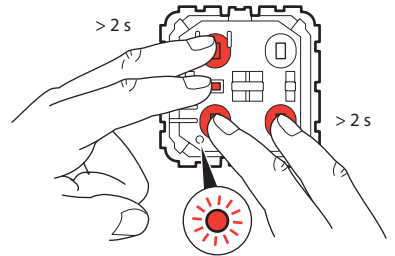

- Retour en mode configuration usine (reconnaissance automatique de charge).
- Terugkeer naar de fabrieksconfiguratiemodus (automatische ladingsherkenning).
- Return to factory configuration mode (automatic load recognition).
- Zurück zum Werkseinstellungsmodus (automatische Lasterkennung).
- Ritorno in modalità configurazione officina (riconoscimento automatico el carico).
- Regresar al modo de configuración de fábrica (reconocimiento automático de carga).
- Regresso ao modo de configuração de fábrica (reconhecimento automático de carga).

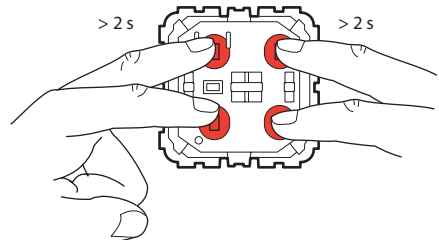

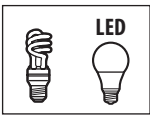

- Réglage du minimum et maximum d'éclairement, recommandé dans le cas de scintillement de la lampe en fonctionnement mini ou maxi du variateur.
(Avant de réaliser les réglages, laisser se stabiliser l'éclairement en laissant la lampe allumée quelques secondes).
- Instelling van de minimale en maximale lichtsterkte, aanbevolen wanneer de lamp flakkert als de dimmer op de minimum- of maximumsterkte is ingesteld.
(Laat, alvorens met het afstellen te beginnen, de verlichting zich stabiliseren door de lamp enkele seconden te laten branden).
- Setting the minimum and maximum lighting level: recommended if the lamp flickers with dimmer operating at minimum or maximum level.
(Leave the lamp switched on for a few seconds before changing the settings to allow the lighting level to settle.)
- Einstellen der minimalen und maximalen Beleuchtungsstärke, empfohlen beim Flackern der Leuchte wenn der Dimmer auf Minimal- bzw. Maximalstärke gestellt ist.
(Die Leuchte einige Sekunden eingeschaltet lassen, bevor die Einstellungen vorgenommen werden, damit sich die Beleuchtungsstärke stabilisieren kann.)
- Regolazione livello di illuminazione minimo e massimo, raccomandata in caso di sfarfallio della lampada in funzione del min o max del dimmer.
(Prima di fare le regolazioni, lasciare la lampada accesa per alcuni secondi per stabilizzare il livello di illuminazione).
- Ajuste del mínimo y máximo de iluminación, recomendado en el caso de que la lámpara parpadee en funcionamiento mínimo o máximo del variador.
(Antes de realizar los ajustes, deje que se establezca la iluminación dejando la lámpara encendida unos segundos).
- Ajuste do mínimo e máximo de iluminação, recomendado em caso de cintilamento da lâmpada em funcionamento mín ou máx do variador.
(Antes de realizar os ajustes, permitir que a iluminação estabilize deixando a lâmpada acesa alguns segundos).

- Réglage seuil haut
- Instelling bovengrens
- Upper threshold setting
- Einstellen der oberen Schwelle
- Regolazione limite alto
- Ajuste del umbral máximo
- Ajuste nível alto

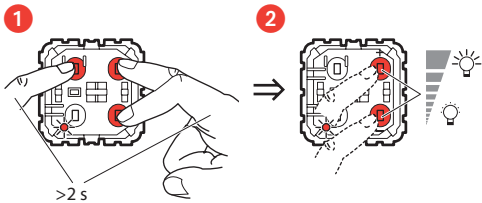

- Réglage seuil bas
- Instelling ondergrens
- Lower threshold setting
- Einstellen der unteren Schwelle
- Regolazione limite basso
- Ajuste del umbral mínimo
- Ajuste nível baixo

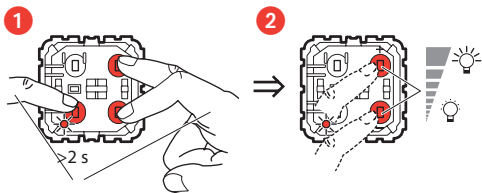

- Validation seuil haut (clignotement bleu 4)
- Valideren bovengrens (knippert blauw 4)
- Confirm upper threshold (flashes in blue 4)
- Validieren der oberen Schwelle (blaues Blinken 4)
- Conferma limite alto (luce blu lampeggiante 4)
- Validación del umbral máximo (parpadeo azul 4)
- Validação nível alto (intermitência azul 4)

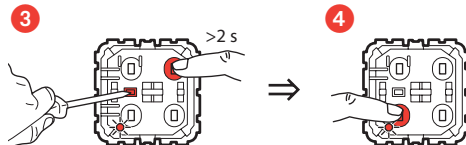

- Validation seuil bas (clignotement bleu 4)
- Valideren ondergrens (knippert blauw 4)
- Confirm Lower threshold (flashes in blue 4)
- Validieren der unteren Schwelle (blaues Blinken 4)
- Conferma limite basso (luce blu lampeggiante 4)
- Validación del umbral mínimo (parpadeo azul 4)
- Validação nível baixo (intermitência azul 4)

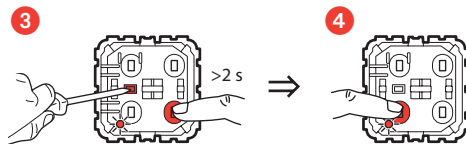



- Désactivation mémoire de niveau
- Uitschakeling geheugen niveau
- Level memory deactivation
- Deaktivierung der Niveau-Speicherung

- Disattivazione funzione memoria
- Desactivación memoria de nivel
- Desactivação memória de nível

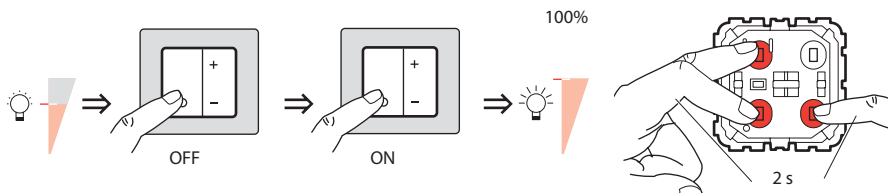

- Activation mémoire de niveau (préréglé en usine)
- Aktivierung der Niveau-Speicherung (werksvoreingestellt)
- Level memory activation (factory presetting)
- Inschakeling geheugen niveau (fabrieksinstelling)

- Attivazione funzione memoria (impostazione di fabbrica)
- Activación memoria de nivel (preajustado en fábrica)
- Activação memória de nível (predefinido de fábrica)

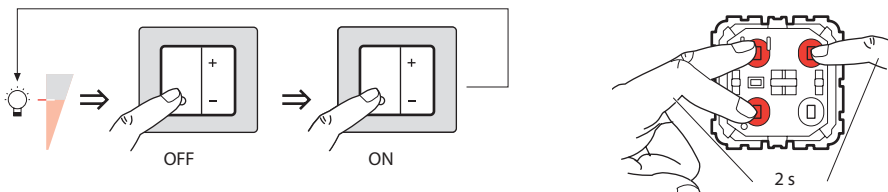



- Mode niveaux pré réglés
- Vooraf ingest. niv.
- Preset levels mode
- Niveau-Voreinstellungs-Modus

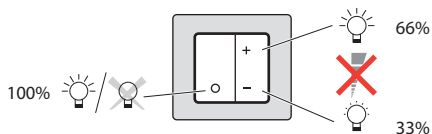

- Modalità livello preset
- Modo niveles preajustado
- Modo níveis predefinidos

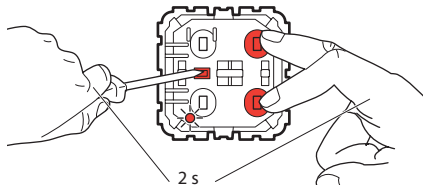

- Mode niveaux pré réglés + veilleuse
- Modus vooraf ingestelde niveaus + stand-by
- Preset levels + night light mode
- Niveau-Voreinstellungs-/Nachtlicht-Modus

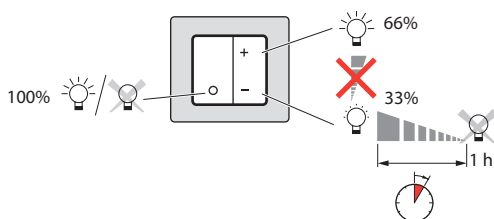

- Modalità livelli preset + luce notte
- Modo niveles preajustados + luz de noche
- Modo níveis pré-ajustados + luz de presença

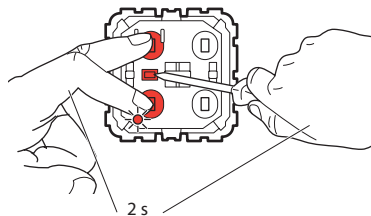

- Mode variateur (pré réglé en usine)
- Dimmermodus (fabrieksinstelling)
- Dimming mode (factory presetting)
- Dimmer-Modus (werksvoreingestellt)

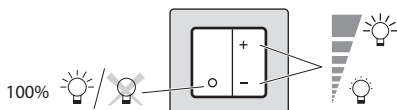

- Modalità regolazione (impostazione di fabbrica)
- Modo variador (preajustado en fábrica)
- Modo variador (predefinido de fábrica)

